

# CHROMA METER CL-200

INSTRUCTION MANUAL



MINOLTA

# Safety Symbols

The following symbols are used in this manual to prevent accidents which may occur as result of incorrect use of the instrument.



Denotes a sentence regarding a safety warning or note.

Read the sentence carefully to ensure safe and correct use.



Denotes a prohibited operation.

The operation must never been performed.



Denotes an instruction.

The instruction must be strictly adhered to.



Denotes an instruction.

Disconnect the AC adapter from the AC outlet.















Denotes a prohibited operation.

Never disassemble the instrument.

## **SAFETY PRECAUTIONS**

- To ensure correct use of this instrument, read the following points carefully and adhere to them. After you have read this manual, keep it in a safe place where it can be referred to anytime a question arises.

 <b>WARNING</b> (Failure to adhere to the following points may result in death or serious injury.)	
 Do not use the instrument in places where flammable or combustible gases (gasoline fumes etc.) are present. Doing so may cause a fire.	 Take special care not to allow liquid or metal objects to enter the instrument. Doing so may cause a fire or electric shock. Should liquid or metal objects enter the instrument, turn the power OFF immediately, remove the batteries (or disconnect the AC adapter from the AC outlet), and contact the nearest Minolta-authorized service facility.
 Always use the AC adapter supplied as a optional accessory, and connect it to an AC outlet of the rated voltage and frequency. Using a non-specified AC adapter or connecting it to an incorrect AC outlet may damage the instrument or AC adapter, causing a fire or electric shock.	 The instrument should not be operated if it is damaged or AC adapter is damaged, or if smoke or odd smells occur. Doing so may result in a fire. In such situations, turn the power OFF immediately, remove the batteries (or disconnect the AC adapter from the AC outlet), and contact the nearest Minolta-authorized service facility.
 If the instrument will not be used for a long time, disconnect the AC adapter from the AC outlet. Accumulated dirt or water on the prongs of the AC power cord's plug may cause a fire and should be removed.	 Do not put the batteries on a fire, charge them (if they are not chargeable), short-circuit them, heat them or disassemble them. Doing so may cause an explosion or heat generation, resulting in fire or injury.
 Do not disassemble or modify the instrument. Doing so may cause a fire or electric shock.	 Do not put the batteries on a fire, charge them (if they are not chargeable), short-circuit them, heat them or disassemble them. Doing so may cause an explosion or heat generation, resulting in fire or injury.

 <b>CAUTION</b> (Falling to adhere to the following points may result in injury or damage to the instrument or other property.)	
 Do not use batteries other than those specified by MINOLTA. When installing batteries in the instrument, make sure that they are correctly oriented according to the (+) and (-) marks. Also make sure not to mix new and old batteries, or mix batteries of different types. Failure to adhere to these instructions may cause batteries to explode or leakage of electrolyte, resulting in fire, injury or air pollution.	
 The socket-outlet shall be installed near the machine and shall be easily accessible.	

## Notes on Use

- This is a precision instrument, and should be handled with due care.
- Read through this manual before powering up this instrument for the first time.
- Always set the power switch to OFF position (the "O" side) before attaching or removing the receptor head.
- To conserve batteries, keep the power switch set to the OFF position while the instrument is not in use.
- Take care to keep the receptor window clean and free of scratches. Keep the cap on when the window is not in use.
- Do not press or push on the display, or subject the display to impacts or other excessive forces.
- This instrument is designed for use at ambient temperature between -10 and 40°C at relative humidity no higher than 85% (at 35°C). Please do not use this instrument in environments outside this range.
- Keep in mind that the instrument may become considerably hotter than the surrounding environment if left under direct sunlight or near a heater or other such device. Exercise due care when using the instrument in these types of locations.
- The spherical summit of the receptor window is used as the illuminance reference plane.
- Exposure to strong external electromagnetic noise may in rare cases interfere with the correct functioning of the instrument's internal microprocessor, resulting in misoperation. If this should occur, disconnect the power briefly (remove the batteries or disconnect the AC adapter), then reconnect the power and restart the instrument.
- Do not use this instrument at altitudes above 2000 meters (6560 ft).
- This instrument is an Installation Category II product. Be sure to use the specified power source when powering this instrument from an AC adapter.
- This instrument is a Pollution degree II product. Avoid use in environments where the instrument may be exposed to metallic dust or condensation.

## How to Clean

- If the instrument gets dirty, wipe it with a dry cloth or silicon cloth. Never use solvents such as thinner and benzene.
- If the receptor window gets very dirty, wipe it gently with a soft dry cloth. If the dirt cannot be removed or the receptor window is scratched, contact the nearest authorized Minolta service facility.
- In cases of malfunction, do not disassemble the CL-200 or attempt to repair it yourself. Contact the nearest Minolta-authorized service facility.

## How to Store

- This instrument should be stored at temperatures of between -20 and 55°C at 85% or less relative humidity (at 35°C). Do not store this instrument in hot and humid areas or areas where condensation is likely to occur. For protection, this instrument should be stored at normal temperatures with a drying agent such as silica gel.
- Do not leave the instrument near the rear window or inside the trunk of a car. Under strong sunlight, the increase in temperature can be extreme and may result in breakdown or deformation.
- If you are not going to use the instrument for 2 or more weeks, remove the batteries from the instrument. Failure to do so may cause leakage of electrolyte, resulting in damage to the instrument.

# CONTENTS

<b>SAFETY PRECAUTIONS</b> .....	1
<b>Names and Functions of Parts</b> .....	4
● <b>Basic Operations</b> ● .....	7
<b>Preparation</b> .....	8
Installing the Receptor Head .....	8
Removing the Receptor Head .....	8
Selecting measuring units .....	8
Attaching the Strap and the Cap .....	9
Attaching the Cap (Without the Strap) .....	9
Placing the CHROMA METER into the Case .....	10
Installing the Batteries .....	11
Turning On the Power .....	12
Zero Adjustment .....	12
Battery Alarm .....	12
<b>Setting the Calibration Mode</b> .....	13
Calibration Modes .....	13
Setting CFs for Each Mode .....	13
Setting the CFs for NORM calibration mode .....	13
Setting the CFs for MULTI calibration .....	13
<b>Taking Color Measurements</b> .....	14
Measuring Method .....	14
Low-Light Alert .....	15
Over Alert .....	15
<b>Taking Color-Difference Measurements</b> .....	16
Setting the Target Color .....	16
Taking the Difference Measurement .....	21
<b>Measuring the Correlated Color Temperature</b> .....	22
<b>Using External Power</b> .....	23
Connecting the AC Adapter .....	23
● <b>Advanced Operations</b> ● .....	25
<b>Using Correction Factors (CFs)</b> .....	26
Using CF Correction .....	26
Setting the CFs .....	26
Applying CF Correction to Measurements .....	30
<b>Printing Out The Measurement Results (Digital Output)</b> .....	31
Printer Requirements .....	31
Compatible printer (example) .....	31
<b>Connecting the CHROMA METER to a Computer (Digital Output)</b> .....	33
<b>Separating the Receptor Head from the Body</b> .....	34
Required Options .....	34
Setting Up .....	34
Fixing the Receptor Head in Place .....	35
<b>Multi-Point Measurement</b> .....	36
Required Options .....	36
Setting Up and Taking Measurements .....	36
<b>More about Multi-Point Measurement</b> .....	39
● <b>Accessories</b> ● .....	41
<b>Included Accessories</b> .....	42
<b>Optional Accessories</b> .....	43
<b>System Configuration Diagram</b> .....	44
● <b>Error Messages and Product Specifications</b> ● .....	45
<b>Error Messages</b> .....	46
<b>Dimension Diagram / Illuminance Reference Plane</b> .....	47
<b>Illuminance Measurement Capabilities</b> .....	48
Relative Spectral Response .....	48
Cosine Correction Characteristics .....	49
<b>Specifications</b> .....	50
<b>Reference</b> .....	51
Chromaticity (xy) .....	51
Correlated Color Temperature (T <sub>cp</sub> ) .....	51

# Names and Functions of Parts

## CL-200

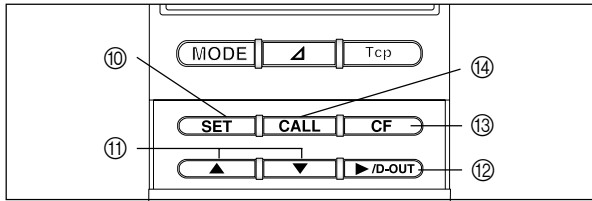
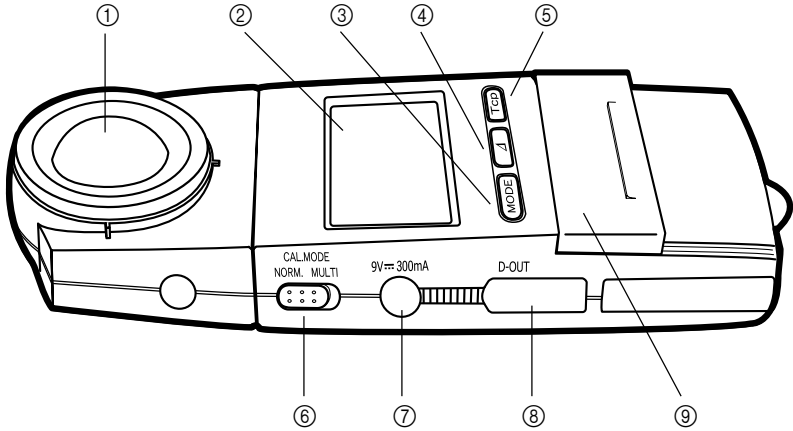

(▲ When the slide cover is open)

- ① Receptor Window
- ② Display
- Mode selector keys
  - ③ [MODE] key ..... Sets the instrument into color measurement mode, and switches the color coordinates.
  - ④ [Δ] key ..... Sets the instrument into color-difference measurement mode, and switches the color-difference display.
  - ⑤ [Tcp] key ..... Selects color-temperature measurement/display mode.
- ⑥ CAL MODE switch ..... Selects the calibration mode: either NORMAL or MULTI.
- ⑦ AC adapter jack ..... Connects to an optional AC adapter AC-A10 (AC-A10N in North America).
- ⑧ Digital output terminal ..... Outputs measurement data to a computer, printer, or other peripheral.

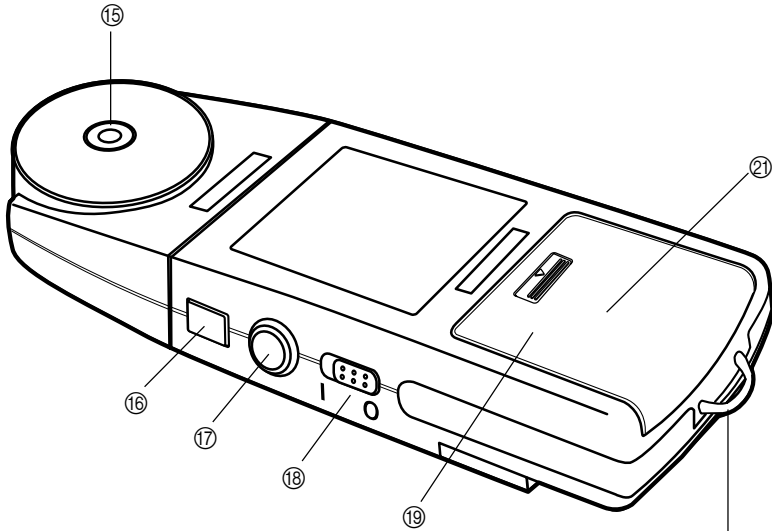

- ⑨ Slide cover
- ⑩ [SET] key ..... • Sets the instrument into SET mode.  
• Registers a numeric setting into memory.
- ⑪ [▲][▼] keys ..... Use the keys to change a numeric value or move the decimal point.
- ⑫ ►/D-OUT] key ..... • In modes other than SET mode, use this key to output measurement data to a printer or computer.  
• In SET mode, use this key to select the digit whose value you want to change with the [▲] or [▼] key.
- ⑬ [CF] key ..... Use this key to switch use of correction factor ON or OFF, and to set the CF.
- ⑭ [CALL] key ..... Displays relevant setting from memory.
- ⑮ Tripod socket
- ⑯ Receptor-head release button ..... Pressing this button detaches the receptor head from the main body.
- ⑰ HOLD button
  - RUN position ..... When this button is popped out, the CHROMA METER takes continuous measurements.
  - HOLD position ..... When you press the button in, the CHROMA METER pauses measurement operation and saves the most recent measurement result. When you press the button again, the button pops out and measurement resumes.
- ⑱ Power switch
- ⑲ Battery cover
- ⑳ Strap hook
- ㉑ Measuring-unit selector ..... Allows selection of lx or fcd.  
(Screen examples given in this manual are mainly for lx.)  
(Inside the battery chamber, refer to page 8)





# ***Basic Operations***

---

# Preparation

## Installing the Receptor Head

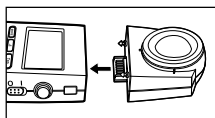

1. Attach the receptor head to the main body.

## Removing the Receptor Head

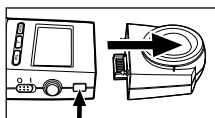

1. Hold down the receptor-head release button and pull the receptor head off.
  - Always set the power switch to the OFF position (the “○” side) before attaching or removing the receptor head. Attaching or removing the head while the power is ON may generate an error.

## Selecting measuring units

The Minolta Illuminance Meter allows you to take readings in either Lux (lx.) or Foot-candle (fcd) units.

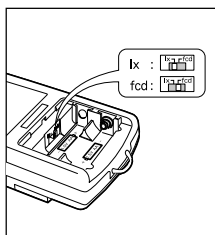

1. Set the power switch to “○” (OFF), and pull the battery cover while pressing it down slightly.
2. Remove two AA-size batteries, if it exits.
3. Set the measuring-unit selector to the desired position (lx. or fcd).
4. Pull back those batteries and battery cover.

## Display example

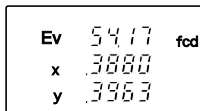
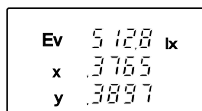

## Attaching the Strap and the Cap

If you are using the strap, attach the cap to the strap as shown below.

1. Pass the strap through loop of the cap string and then through the strap hook, and then pass one end of the strap through the other.

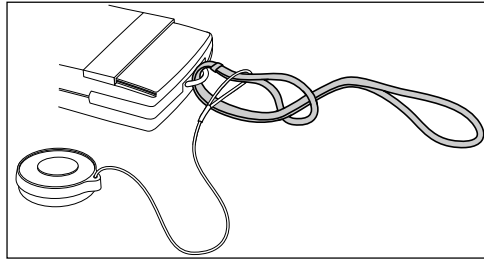

## Attaching the Cap (Without the Strap)

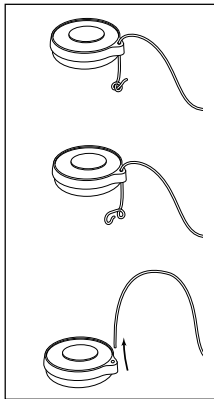

If you are not using the strap, attach the cap to the main body as follows.

1. Untie the knot holding the cap string to the cap, and remove the string from the cap.

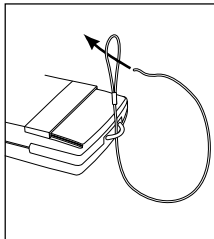

2. Attach the string to the strap hook as shown in the illustration.

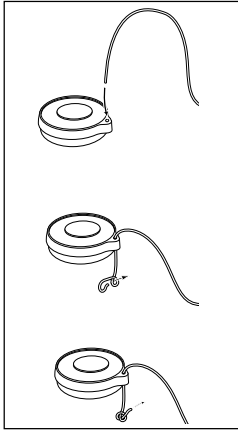

3. Pass the string back through the hole in the cap, and tie a knot at the end of the string so that the cap cannot come off.

### Placing the CHROMA METER into the Case

Set the cap onto the receptor window, and slide the CHROMA METER into the case.

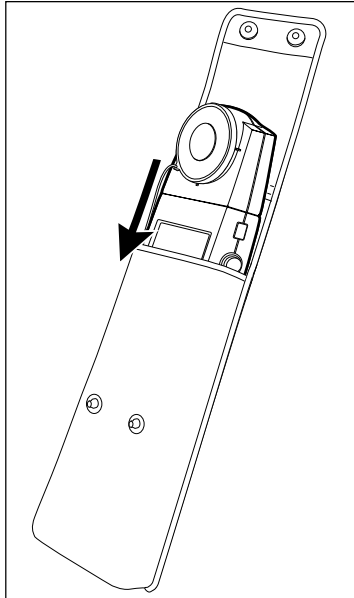

## Installing the Batteries

### ⚠ WARNING

- ⊘ Do not allow batteries to come into contact with fire, and do not charge them (unless they are specifically designated as rechargeable), heat them, or take them apart. Any of these actions may cause batteries to overheat or explode, possibly resulting in fire or injury.

### ⚠ CAUTION

- ⊘ Do not use battery types that are not specified for this instrument. Never mix old and new batteries, or different types of batteries. Be sure to load batteries with the (+) and (-) polarities in the correct direction. Neglecting any of these precautions may result in battery leakage or explosion, possibly resulting in fire, injury, or environmental damage.

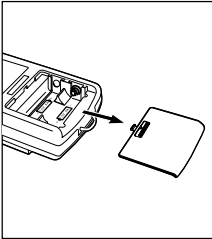

1. Set the power switch to OFF (“O”). Press down lightly on the battery cover and pull it off.

- Have two AA batteries ready.

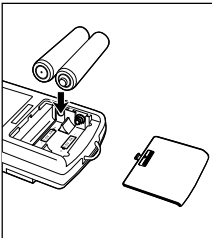

2. Place the batteries into the compartment. Be sure that the + and - ends match the markings in the compartment. Then reattach the cover.

- When replacing batteries: Remove both of the old batteries first, and then install the new batteries.

## Turning On the Power

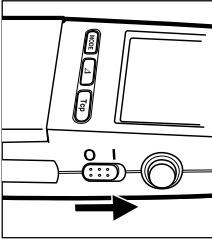

1. Set the power switch to the ON position ("I").

- If the HOLD button is in the RUN position (popped out) when you turn on the power, the CHROMA METER begins taking measurements immediately.
- If the HOLD button is in the HOLD position (pressed in) when you turn on the power, the CHROMA METER will not begin taking measurements until the you pop the button out.

## Zero Adjustment

The CHROMA METER performs zero adjustment automatically when the power comes on.

- The display shows the letters "CAL" to indicate that zero adjustment is in progress. The "CAL" indication goes off when this adjustment is completed.
- This adjustment is carried out electronically. There is no need to attach the cap.

## Battery Alarm

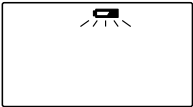
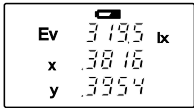

When batteries start to run low, a battery mark appears above the measurements on the display. As batteries run lower still, the mark will begin to blink—at which time the CHROMA METER will no longer be able to take measurements. Replace the batteries to restore normal operation.

- Fresh alkaline batteries should provide enough power at least 60 hours of continuous measurements (at room temperature).

When replacing batteries: Remove both of the old batteries first, and then install the new batteries.

# Setting the Calibration Mode

## Calibration Modes

The CL-200 CHROMA METER offers two calibration modes: NORM and MULTI. Select the appropriate mode using the CAL MODE switch.

### NORM

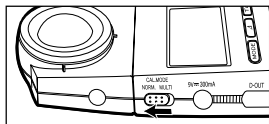

When you select this mode, the CHROMA METER uses reference light source A as the calibration source.

This mode is recommended for measurement of normal light sources (light sources with continuous spectral distributions).

### MULTI

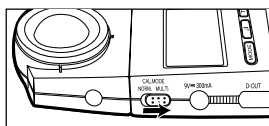

When you select this mode, the reference light source is an LCD projector with a UHP (ultra-high-pressure) mercury lamp. The CHROMA METER calibrates R, G, and B tricolor components separately, and then implements W correction.

This mode allows for high precision measurement of all colors. The mode is appropriate for measuring a tricolor-addition light source whose spectral distribution is approximately the same as that of the reference source.

## Setting CFs for Each Mode

The CL-200 CHROMA METER can store CFs (correction factors) for both calibration modes, and can apply these to your measurement results. You can use this feature to correct for disparities among different CL-200s or to adjust calibration arbitrarily as needed. After setting the CFs, you can use the [CF] key to switch use of CF correction ON or OFF.

### Setting the CFs for NORM calibration mode

You set the CFs by taking a measurement of a known light source, then keying in the corresponding known values. For details, see page 26.

### Setting the CFs for MULTI calibration

You set the CFs by measuring the three color components (R, G, and B) of the light source (a CRT or LCD projector) and then keying in the known reference values. You can also measure the W component and key in a W reference value, allowing for W correction as well.

Setup of CFs for MULTI calibration mode is carried out by (optional) CL-S1w data management software. For information about how to use the CL-S1w to set these CFs, refer to the CL-S1w online help.

# Taking Color Measurements

- When taking measurements, be careful to hold the CHROMA METER so that the receptor window is clear of shadows (such as your own shadow) and reflected light.
- Illuminance unit is selectable lx or fcd. (page 8)

## Measuring Method

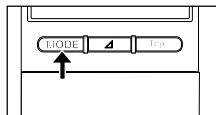

1. Press [MODE].

- ◆ The CHROMA METER enters color measurement mode.
- You can now press [MODE] again to change the display mode. Each press cycles you to the next display mode, as shown in the illustration.

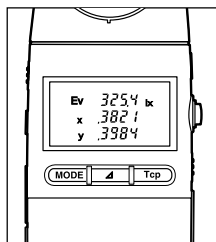
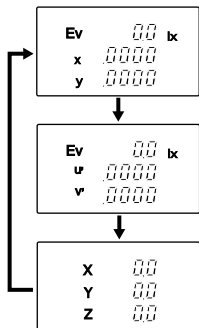

2. Set the HOLD button to the RUN position (pop the button out).

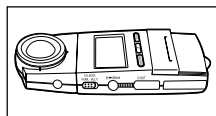

3. Aim the receptor at the light source you want to measure.

- ◆ The display shows the measurement result.
- If you wish to hold the measurement, push in the HOLD button. (If the measurement intensity is 10 lx (1fcd) or less, the display's backlight will come on for 30 seconds.)
- To cancel the hold, press and then release the hold button (so that it pops out).

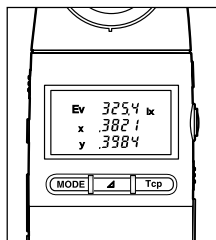



## Low-Light Alert

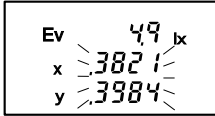

(Values blink to indicate low illuminance)

If the measured illuminance is less than about 5 lx (0.5 fcd), some of the measured values on the display will blink. The blinking display lets you know that the illuminance is low.

Specifically, the following values will blink to alert you of this condition: x, y,  $u'$ ,  $v'$ , T,  $\Delta u v$ ,  $\Delta x$ ,  $\Delta y$ ,  $\Delta u'$ ,  $\Delta v'$ , and  $\Delta u'v'$ .

## Over Alert

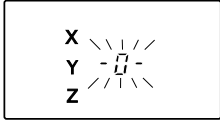

(Blinking “-0-” display)

If any of the measured values exceeds the measurement range, the display will show a blinking “-0-” in place of the measurement results.

# Taking Color-Difference Measurements

Use the procedure described below to measure the difference between the sample color and a target color. You can select any of four color-difference displays: (a)  $\Delta E_v \Delta x \Delta y$ , (b)  $\Delta E_v \Delta u' \Delta v'$ , (c)  $\Delta E_v \Delta u'' \Delta v''$  or (d)  $\Delta X \Delta Y \Delta Z$ .

## Setting the Target Color

You can set the target color values in either of two ways.

- ① Measure a source, and use the measurement results as the target.
- ② Key in the target values manually.

### ① Using a Measurement Result as the Target

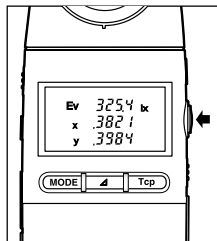

1. Measure the color of a source as described under “Taking Color Measurements” (page 14). When the display shows measurement results that you feel are satisfactory for use as your target values, press the HOLD button to hold these results.

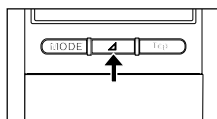

2. Press  $[\Delta]$ .

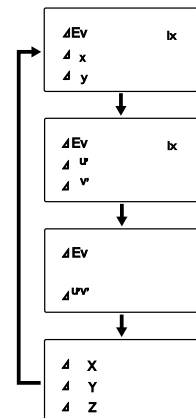

- ◆ The display changes to show color-difference parameters.
- You can now press  $[\Delta]$  again to change the display mode. Each press cycles you to the next mode, as shown in the illustration.

- If you have previously set a target, the display shows the difference between the new measurement and this previously set target.

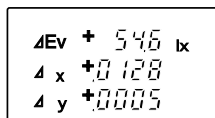

Sample Display

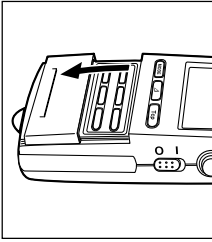

3. Open the slide cover, and press **[SET]**.

- ◆ The CHROMA METER enters SET mode, and the display appears as shown in the illustration.
- ◆ The measurement results that you held at Step 1 above now blink on the display.
- If you wish to cancel without registering the blinking values as your new target, press **[CALL]**.

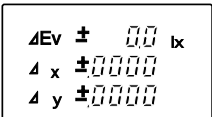
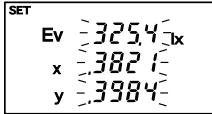
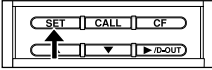

All values become  $\pm 0$ .

4. Press **[SET]** again.

- ◆ The CHROMA METER writes the measured values into the target memory, so that they become the current target values. The displayed values accordingly change to “ $\pm 0$ ” (where the number of digits on each line varies according the display mode), since the measured values and target values are now identical.

- You can review the target values at any time by holding down the **[CALL]** key. The values remain on the screen until you release the key.
- When taking the measurement for the target value, please use the same display mode that you intend to use when taking the color difference measurements. Changing the display mode after measuring the target may result in errors in the difference results. (If you are going to measure color difference using  $\Delta E_v \Delta x \Delta y$  mode, take the target measurement using  $E_v x y$  mode.)

## ② Manually Keying in the Target Values

The following procedure takes you through the steps necessary to manually enter target values when using  $\Delta E \Delta x \Delta y$  display mode. The entry procedure for other display modes is essentially the same.

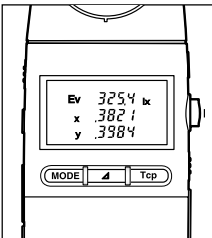

1. Press the **[MODE]** key (to set the CHROMA METER into color-measurement mode, page 14), and pop out the HOLD button (into RUN position).

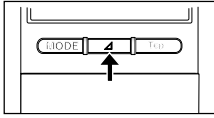

2. Press [Δ].

- ◆ The display shows color-difference parameters.

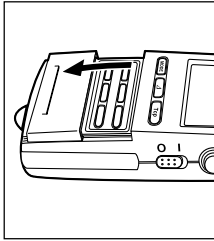

3. Open the slide cover, and press [SET].

- ◆ The CHROMA METER enters SET mode, and waits for you to begin keying in the target values. The display content varies according to whether target values have already been stored, as follows.

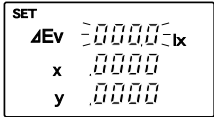

- If no target is currently set, the display shows 0's for all parameters (where the number of digits varies according to the parameter). The first line is blinking.

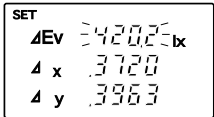

- If you have previously set a target, the target values are shown. The first line is blinking.

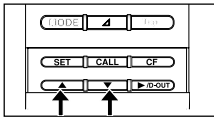

4. Use [▲] or [▼] to select the parameter (the line) you wish to set.

- The digits on the selected line blink.
- Press [▲] or [▼] as necessary to move the blinking indication to the line you want to set.

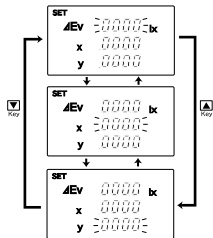

- You can now enter a value for the selected line (parameter). Note that some parameters also allow you to set the number of significant digits. The entry method varies according to whether significant digits can or cannot be changed. To set a value for Ev, x, y, or z, proceed from Step 5 below. To set a value for x, y, u', or v', proceed from Step 10.

○ To enter a value for Ev, x, y, or z

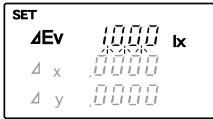
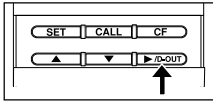

5. Press **[▶/D-OUT]**.

- ◆ One or more decimal points begin blinking.
- If a target value is already set for this parameter, the value is displayed. The value's decimal point blinks.
- If the set target value does not have a set decimal point, all three of the line's decimal points blink.

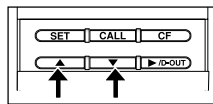

6. Press **[▲]** or **[▼]** as necessary to select the number of significant digits for the selected parameter.

- If you use the **[▲]** key, the number of digits changes as shown in the illustration. If you use the **[▼]** key, the action moves in the reverse direction.

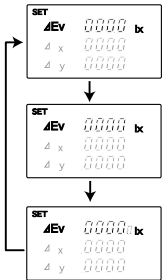

7. Press **[▶/D-OUT]** as necessary, so that the digit you want to set next starts blinking (becomes active).

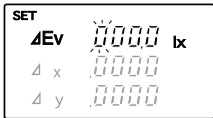
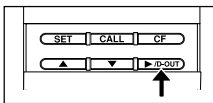

8. Press **[▲]** or **[▼]** as necessary to change the value of the active digit.

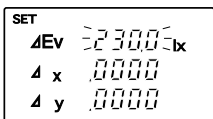
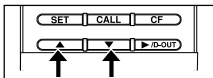

9. Repeat steps 7 and 8 as necessary to set values for all digits.

- ◆ When you have entered values for all digits, the entire value (all digits) will blink.
- You can cancel the entry procedure by pressing **[CALL]**.

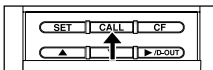

- When you are ready to move to another line, return to Step 4.

○ To enter a value for x, y, u', or v'

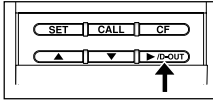

10. Press [►/D-OUT] as necessary, so that the digit you want to set next starts blinking (becomes active).



11. Press [▲] or [▼] as necessary to change the value of the active digit.

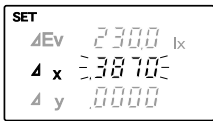
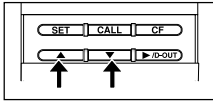

12. Repeat steps 10 and 11 as necessary to set values for all digits.

- ◆ When you have entered values for all digits, the entire value (all digits) will blink.
- You can cancel the entry procedure by pressing the [CALL] key.

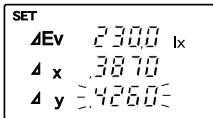
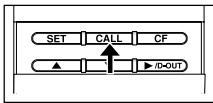

13. Repeat steps 4 to 12 as necessary to set values for all parameters.

- You can cancel the entry procedure by pressing the [CALL] key.

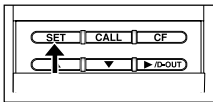
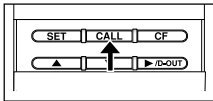

14. Recheck you entries to be sure that they are correct, and then press [SET] to register them.

- ◆ The CHROMA METER writes the entered values into the target memory, so that they become the target values.

- You can view the currently set target values by pressing [CALL].
- If any of the values you have entered are outside of the permissible range for the corresponding parameter, the CHROMA METER displays the "Err A" error message and then cancels SET mode (without registering any of the entered values).

## Taking the Difference Measurement

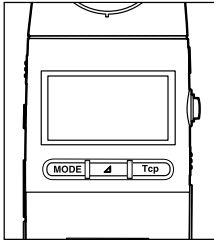

1. Press and release the HOLD button, so that it pops out (into RUN position).

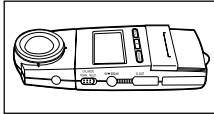

2. Aim the receptor at the light source you want to measure.

- ◆ The display shows the measurement results (the difference results).
- You can change the display mode by pressing  $[\Delta]$  as necessary. Each press cycles you to the next mode, as indicated at left.

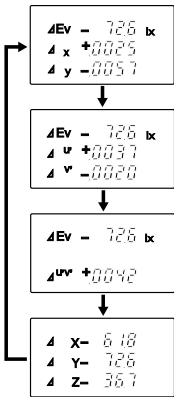

- You can review the target values at any time by holding down the [CALL] key. The values remain on the screen until you release the key.

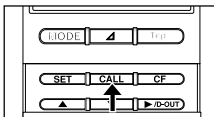

- The CHROMA METER will continue to use the currently stored target values. If you wish to change the target values, you must set new ones using the procedures described on pages 16 to 20.
- If you wish to clear the stored target values, manually input 0's into each target value field (using the manual-input procedure described on pages 17 and 18). If target values are cleared, the CHROMA METER will no longer display color differences.
- The CHROMA METER can measure and display difference values within the following ranges.

$\Delta Ev$ (lx):	(0 – target value) to (99,990 – target value)
$\Delta Ev$ (fcd):	(0 – target value) to (9,999 – target value)
$\Delta x, \Delta y, \Delta u', \Delta v'$ :	-0.9999 to 0.9999
$\Delta u'v'$ :	0 to 0.9999

# Measuring the Correlated Color Temperature

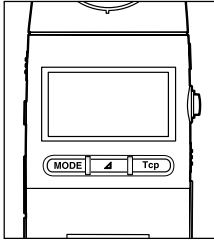

1. Press and release the HOLD button, so that it pops out (into RUN position).

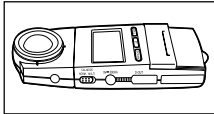

2. Aim the receptor at the light source you want to measure.

- ◆ The display shows the measurement results.
- Press [**Tcp**] to display the correlated color temperature.

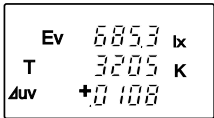
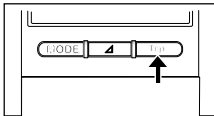

- The CHROMA METER can display color temperature values from 2300 to 20000 K.
- The CHROMA METER can display  $\Delta uv$  values up to (but no including) 0.1.
- If either the temperature reading or the  $\Delta uv$  value is outside the display range, the CHROMA METER will display “----” for both values.



# Using External Power

## WARNING

- ❗ Use only the AC adapter specified for this instrument, and connect the adapter only to an AC outlet of rated voltage and frequency. Use of a different adapter or incorrect power source may cause damage to the instrument and adapter, and poses risk of fire or electric shock.
- 🔌 Disconnect the AC adapter from the outlet if you are not going to use the instrument again for a prolonged period. If the plug area is dirty or damp, clean it before inserting the plug into the outlet. Insertion of the plug while it is dirty or wet constitutes a fire hazard.
- ❗ Do not continue using the instrument (or the AC adapter) if the instrument (or adapter) becomes damaged or starts to emit smoke or unusual odors. Continued use under these conditions constitutes a fire hazard. Switch the instrument off immediately and remove the batteries (or disconnect the adapter from the outlet). Then contact the nearest Minolta-authorized service facility for assistance.

## CAUTION

- ❗ Read through this manual before powering up this instrument for the first time.
- ❗ The voltage/ampere rating of the AC adapter jack's is 9V DC / 300mA. The jack's outer polarity is positive (+), and the inner polarity is negative (-). This instrument is designed for use with the Minolta AC adapter AC-A10 (AC-A10N in North America) only. (The adapter is sold separately.) Please do not use any other adapter with this instrument.

## Connecting the AC Adapter

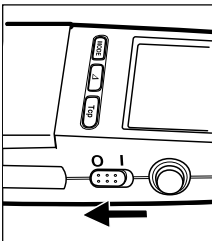

1. Set the power switch to OFF (“O”).

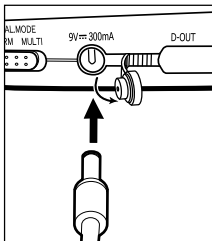

2. Connect the AC adapter to the AC adapter jack on the chroma meter.

3. Plug the AC adapter's plug into an AC outlet.

- Before unplugging the adapter, be sure to set the power switch back to OFF (“O”).



# ***Advanced Operations***

---

# Using Correction Factors (CFs)

This feature is available only when you are using NORM calibration mode (page 13).

## Using CF Correction

The CL-200 CHROMA METER allows you to set correction factors (CFs) that can be applied to your measurement results. You can use this feature to correct for disparities among different CL-200s or to adjust calibration arbitrarily as needed. After setting the CFs, you can use the [CF] key to switch use of CF correction ON or OFF.

## Setting the CFs

You set the CFs in two stages: First you measure a light source whose output values are known, and then you key in the known values. The CHROMA METER calculates the CFs based on the differences between the measured values and the keyed-in values. The CHROMA METER stores the CF settings in nonvolatile memory, so that these values are retained even when you switch off the power or change the batteries.

To set the CF values, follow the steps below.

### ① Measure the Light Source

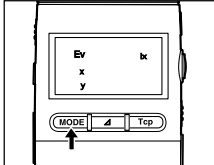

1. Press [MODE] as necessary to move to the Ev x y display, and set the CAL MODE switch to NORM.

- CFs can only be set while the calibration mode is set to NORM and the display is showing the Ev x y color coordinates.

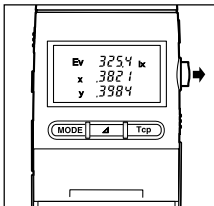

2. Set the HOLD button to the RUN position (pop the button out), and take a measurement of the light source.

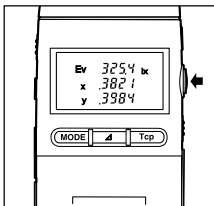

3. Set the HOLD button to the HOLD position (press the button in).

## ② Enter the know values.

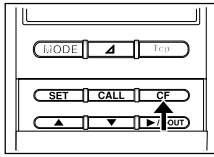

1. Open the slide cover, and press [CF].
  - ◆ The CHROMA METER enters CF mode.

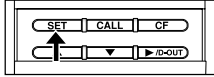

2. Press [SET].
  - ◆ The display shows the measurement results obtained at step ①-3 above. If CF values are already set, the display shows the corrected results.
  - ◆ The value on the Ev line is blinking.
  - ◆ The CHROMA METER is now ready for you to manually enter the known values.

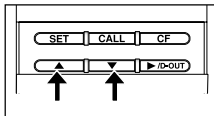
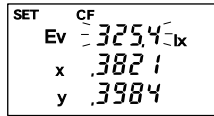

3. Use [▲] or [▼] to select the parameter (the line) you wish to set.
  - The digits on the selected line blink.
  - Press [▲] or [▼] as necessary to move the blinking indication to the line you want to set.

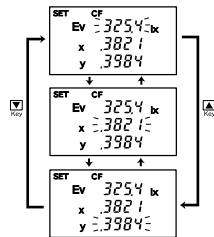

\*Note: Setup of CFs for MULTI calibration mode requires use of the (optional) CL-S1w data management software. (See page 13.)

- You can now enter the correct value (the known value) for the selected line. Note that for the Ev line you can set both the number of significant digits and the value, while on the x and y lines you can set only the value. To set the Ev value, proceed from Step 4 below. To set the x or y value, proceed from Step 9.

## ○ Entering the correct Ev value

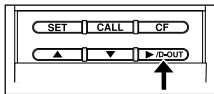

4. Press [D-OUT].
  - ◆ One or more decimal points begin blinking.
  - If a correct Ev value is already set for this parameter, the value is displayed. The value's decimal point blinks.
  - If the set value does not have a set decimal point, all three of the line's decimal points blink.

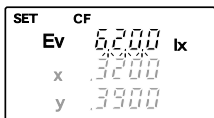
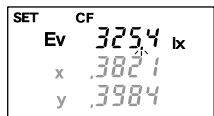

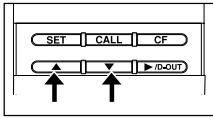

5. Press [▲] or [▼] as necessary to select the number of significant digits.

- If you use the [▲] key, the number of digits cycles as shown in the simplified illustration at left. If you use the [▼] key, the action moves in the reverse direction. (The actual display will show the measurement results held at step ①-3 above. The illustration shows all 0's so that the action is easier to see.)

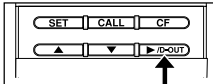
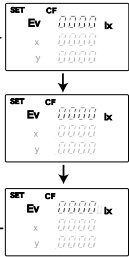

6. Press [▶/D-OUT] as necessary, so that the digit you want to set next starts blinking (becomes active).

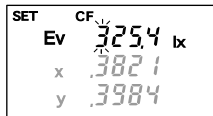

7. Press [▲] or [▼] as necessary to change the value of the active digit.

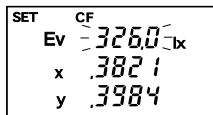
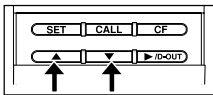

8. Repeat steps 6 and 7 as necessary to set values for all digits.

- ◆ When you have entered values for all digits, the entire value (all digits) will blink.
- You can cancel the entry procedure by pressing [CALL].

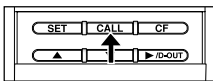

- When you are ready to move to the next line, return to Step 3.

## ○ Entering the correct x or y value

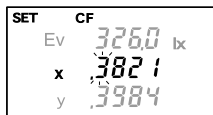

9. Press [▶/D-OUT] as necessary, so that the digit you want to set next starts blinking (becomes active).

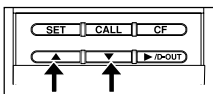

10. Press [▲] or [▼] as necessary to change the value of the active digit.

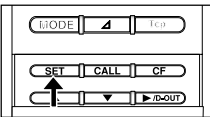
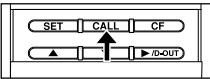
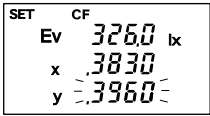
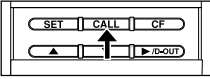
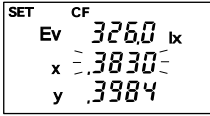

11. Repeat steps 10 and 11 as necessary to set values for all digits.
- ◆ When you have entered values for all digits, the entire value (all digits) will blink.
  - You can cancel the entry procedure by pressing **[CALL]**.

12. Repeat steps 3 to 11 as necessary to set the correct values for all three lines.
- You can cancel the entry procedure by pressing **[CALL]**.

13. Recheck you entries to be sure that they are right, and then press **[SET]** to register them.
- ◆ The CHROMA METER computes the CF values by comparing your entered values with the held measurement values.

- If any of the computed CF values is lower than 0.0001 or higher than 10.0000, the CHROMA METER displays the “Err A” message and forcibly cancels SET mode.
- You can view CF values by pressing **[CF]** (to enter CF mode) and the holding down the **[CALL]** key. The values remain on the screen until you release the key.
- If any of the values you have entered are outside of the permissible range for the corresponding parameter, the CHROMA METER displays the “Err A” error message and then cancels SET mode (without registering any of the entered values).
- If you attempt to set y such that  $y < 1-6.98x$ , the CHROMA METER displays the “Err A” message and forcibly cancels SET mode.

## Applying CF Correction to Measurements

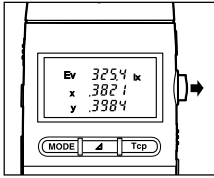

1. Press and release the HOLD button, so that it pops out (into RUN position).
  - ◆ The CHROMA METER begins taking measurements.

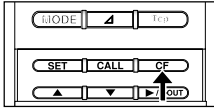

2. Open the slide cover, and press [CF].
  - The display now shows the CF-corrected results. Note that the CF indication appears at the top of the display.

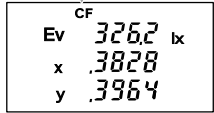

You can toggle CF correction OFF and ON by pressing the [CF] key.

- Stored CF values remain in memory until you change them.
- If you wish to clear the stored CF values, return to the procedure described under “Setting the CFs” (starting on page 26) and manually input 0s into all columns.



# Printing Out The Measurement Results (Digital Output)

This section explains how to print out the CHROMA METER's measurement results. In order to print, you will need both a compatible printer and the (optional) T-A12 printer cable.

## Printer Requirements

The printer must meet the following requirements.

Characters per line	:At least 27
Data input	:RS-232C
Data control	:BUSY
Bits per second	:9600
Character length	:7 bits
Parity	:Even
Stop bits	:1
Basic function	:0Dh carriage return

## Compatible printer (example)

Types: DPU-201GS (from Seiko Instruments, Inc.)

## Procedure

Connect the CHROMA METER to the printer using the T-A12 printer cable, as follows.

- Before making the connection, set the CHROMA METER's power switch to the OFF position ("O"). Also be sure that the printer is off.
- After making the connection, be sure that you switch the CHROMA METER on *before* you turn the printer on. Printing may not work correctly if you switch the printer on first.

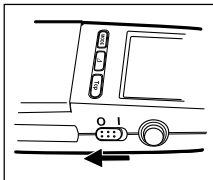

1. Be sure that the CHROMA METER's power switch is in the OFF position ("O"), and that the printer is also off. Then connect one end of the T-A12 cable to the CHROMA METER's digital output terminal, and connect the other end to the printer.

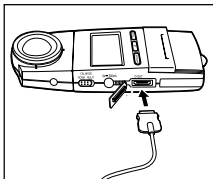

- The illustration shows how to connect to the DPU-201GS printer.

▼ Connecting to the DPU-201GS

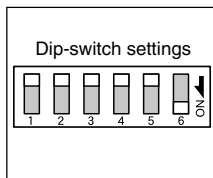
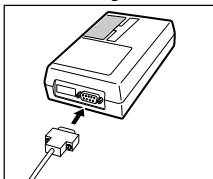

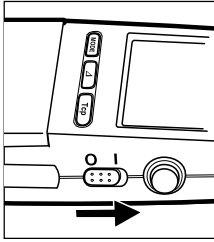

- Set the CHROMA METER's power switch to the ON position ("I"), and then turn on the printer.

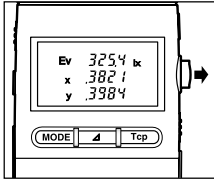

- Set the HOLD button to the RUN position (pop the button out), so that the CHROMA METER begins taking measurements.

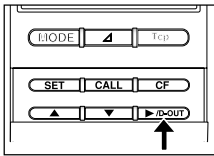

- Press [D-OUT] to send the results to the printer.

- ◆ Each time you press [D-OUT], the CHROMA METER sends its most recent measurement results to the printer.
- If you want to hold the current measurement results, press in the HOLD button. You can then print the held results by pressing [D-OUT].

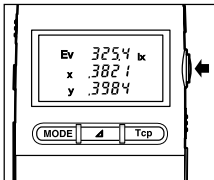

- Connection of the T-A12 cable increases the CHROMA METER's consumed current by about 50%. If you are not going to use the printer, please disconnect the cable.

## Sample Printout (on DPU-201GS printer)

XYZ	(0)	X	Y	Z		
		149.3	190.8	90.0		
		34030	24660	9070		
		OVER				"OVER"
Ev xy	(0)	Ev	X	Y		Measured value exceeded the measurement range.
		105.0	.4940	.3567		
	*	1.7	.4846	.3476		
		OVER				"sg"
Ev u v	(0)	Ev	u	v		Low-light alert (low illuminance)
	*	1.6	.2027	.5095		
$\Delta X \Delta Y \Delta Z$	(0)	dx	dy	dZ		
		+ 16.5	+ 19.3	+ 11.5		
		+ 109.2	+ 96.3	64.7		
$\Delta Ev \Delta x \Delta y$	(0)	dEv	dx	dy		
	*	+ 12.8	+ .0017	+ .0014		
		+ 96.1	+ .0718	+ .0555		
		OVER				
$\Delta Ev \Delta u \Delta v$	(0)	dEv	du	dv		
		+ 8.4	-.0026	-.0001		
$\Delta Ev \Delta uv$	(0)	dEv	duv			
		+ 14.4		+ .0018		
Ev Tcp $\Delta uv$	(0)	Ev	T(K)	duv		
	*	106.7	3219	-.0158		
	*	9.7	2068	-.0138		
	*	0.4				"-----"
	(0)	dx	dy	dZ		Tcp and $\Delta uv$ values are out of range.
		-----	-----	-----		
	(0)	dEv	dx	dy		"-----"
		-----	-----	-----		
	(0)	dEv	du	dv		Color-difference measurement, but no target values were set.
		-----	-----	-----		
		-----	-----	duv		

- When you change the measurement mode (measurement parameters), the printer skips a line, then prints the new parameter names, and then prints out the values.
- For repeated measurements in the same mode, the printer prints only the values (the parameter headings appear only once, at the top).

## **Connecting the CHROMA METER to a Computer (Digital Output)**

You can connect the CHROMA METER to a personal computer using the (optional) T-A11 connection cable. You can then transfer the measurement data to the computer, and use the computer to store and manage the data.

If you install Minolta's optional CL-S1w data processing software on your computer, you will also be able to use the computer to view measurement results in real time and to control multi-point measurements. The software also makes it possible to use CF correction with MULTI calibration mode, a feature that is not available on the CHROMA METER alone. For information about how to use the CL-S1w software, read the program's online help.

- Connection of the T-A11 cable increases the CHROMA METER's consumed current by about 50%. When you have finished using the computer connection, please disconnect the cable.

# Separating the Receptor Head from the Body

For certain applications you may wish to separate the receptor head and connect it to the body by cable. Two optional adapters—one for the head, and one for the body—make this possible.

## Required Options

- Adapter Unit for Main Body T-A20
- Adapter Unit for Receptor Head T-A21 (with cable)

### If you need greater separation

- If the cable included with the T-A21 adapter is not long enough, you can use 10Base-T network cable (Category 5 straight cable, available at computer supply stores) to make or extend the connection. Maximum allowable separation is 100 meters (328 ft).

## Setting Up

- Note that if the connection cable is in proximity to devices that generate electrical noise, the noise may adversely affect measurement results and instrument functions. Keep the cable away from sources of electrical noise when carrying out measurements.

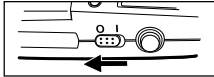

1. Set the power switch to OFF ("O").  
Hold down the receptor-head release button, and pull the head off of the body.

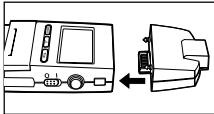

2. Attach the T-A20 to the body.

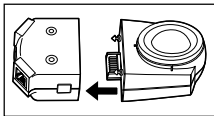

3. Attach the T-A21 to the head.

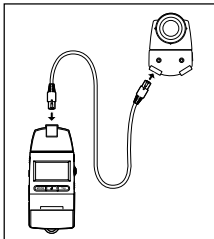

4. Connect the cable to the two adapters.



5. Set the power switch to ON ("I"), and set the HOLD button into RUN position.

◆ The CHROMA METER begins taking measurements.

- Note that the cable connection approximately doubles the CHROMA METER's consumed current.

## Fixing the Receptor Head in Place

When working with the receptor head detached from the main body, you can fix it into position using either of the following two methods. (For a view of the reference measurement plane, see page 47.)

- ① Attach the head to a tripod (using the tripod screw hole on the back of the head).
- ② Mount the head onto a panel (by running screws through the screw holes on the T-A21).

### Dimensions

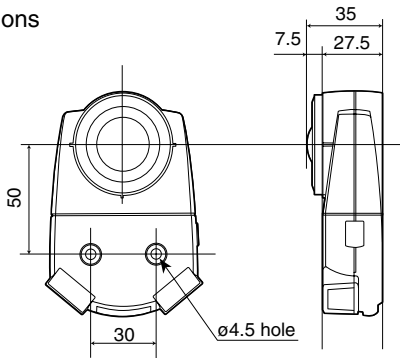

### Fixing the Head to a Panel

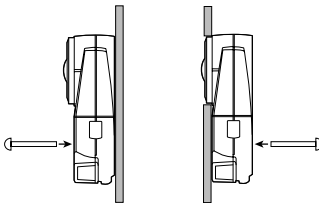

# Multi-Point Measurement

You can set the CL-200 up to take measurements from multiple points at once. You do this by connecting up multiple receptor heads (each with its own adapter). You can connect up to 30 heads. Extra heads and adapters are available as options.

Since all heads must receive a stable power supply, it is essential that you use an (optional) AC adapter to power the system when taking multi-point measurements.

## Required Options

- Adapter Unit for Main Body T-A20
- Additional heads
- Adapter Unit for Receptor Head T-A21, with cable (one T-A21 adapter for each head)
- AC adapter

### If cabling is not long enough

If the cable included with the T-A21 adapter is not long enough, you can use 10Base-T network cable (Category 5 straight cable, available at computer supply stores) to make or extend the connection. When using multiple heads, the maximum allowable total cable length is 50 meters (164 ft).

## Setting Up and Taking Measurements

- Note that if the connection cables are in proximity to devices that generate electrical noise, the noise may adversely affect measurement results and instrument functions. Keep the cables away from sources of electrical noise when carrying out measurements.

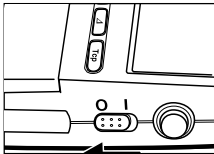

1. Set the power switch to OFF ("O").

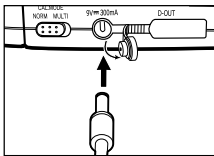

2. Attach the T-A20 to the body.

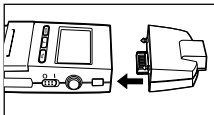

3. Attach a T-A21 to each receptor head.

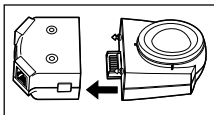

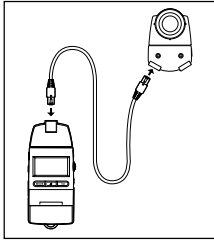

4. Connect the body adapter to one of the head adapters (using the included cable or network cable).

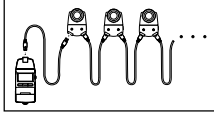

5. Cable the remaining heads together in series.

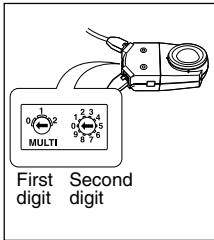

6. Set an ID number for each head, using the rotary switches on the adapters.

- ID numbers run from 00 to 29. The left rotary switch sets the first digit, and the right switch sets the second digit.
- Be sure to set a different ID number for each head.

- When you switch the power ON, the body reads in the ID numbers and sets itself up accordingly. Note that the body will not check the IDs again so long as power remains on. Consequently, it will not recognize any changes that you make to the ID settings while operation is in progress. Be sure to set the power switch to OFF ("O") before changing any of the ID settings.

You might find it helpful to print ID labels and attach them to the corresponding head adapters. This will make it easier to keep track of the correspondence between the heads and the ID numbers.

- ▼ If head adapter is set to ID "09", attach a "9" label.

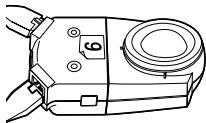

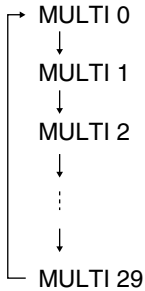
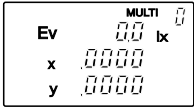

(Highest assigned ID number)

7. Set the power switch to ON ("I").

- ◆ The upper right of the screen shows the lowest used ID number.
- Press [▲] or [▼] as necessary to cycle up or down through the used ID numbers. Confirm that the display cycles through the IDs for all of the connected heads. (The illustration at left shows the cycle sequence when the [▲] button is used.)
- If the display skips any of the IDs that you have set, check the relevant cable connections. Also check again to make sure that all IDs are unique.

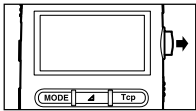

8. Set the HOLD button into RUN position.

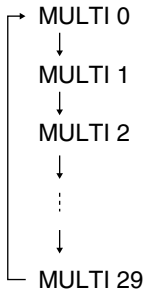

(Highest assigned ID number)

- ◆ The CHROMA METER begins taking measurements from all heads. The display shows the measurements taken by the selected head (the head whose ID number is displayed at the upper right).
- You can select a different head by pressing [▲] or [▼] as necessary. (Press [▲] to cycle upward through the ID numbers, or [▼] to cycle downward.)



# More about Multi-Point Measurement

## Setting the Head ID Numbers

- Be sure to set unique ID numbers for all heads. If you set the same number on more than one head, the CHROMA METER will not be able to carry out measurements correctly.

## About Color-Difference Measurement

- The target values must be set separately for each head.
- Results are shown separately for each head.

## Use of Correction Factors (CFs)

- Use or nonuse of CFs can be set on and off separately for each head.

## About Digital Output

- If you are outputting to a printer through the D-OUT port, the CHROMA METER outputs the currently selected head. You can print out data for other heads by changing the head selection.



# ***Accessories***

---

## Included Accessories

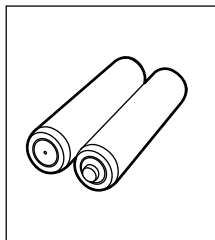

**Batteries**  
**Two AA batteries**

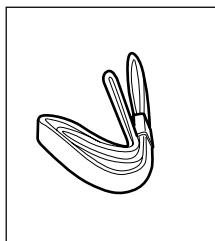

**Strap**

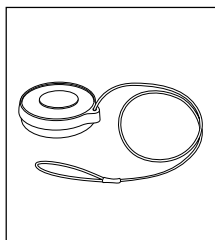

**Cap**

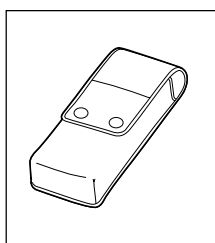

**Case T-A10**

# Optional Accessories

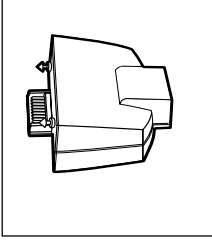

**Adapter Unit for Main Body T-A20**

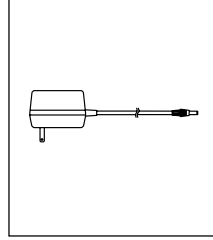

**AC-Adapter AC-A10 (worldwide except North America)**

**AC Adapter AC-A10N (North America)**

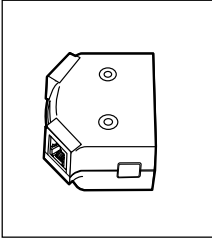

**Adapter Unit for Receptor Head T-A21**

- With an extension cable (1m)

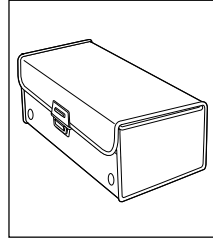

**Hard Case CL-A10**

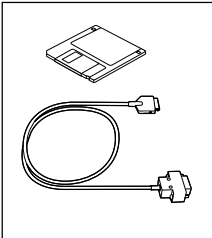

**Data Management Software Kit CL-S1w**

- Includes T-A11 connection cable

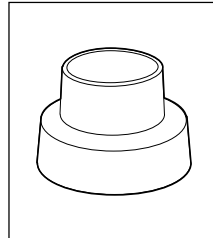

**Hood CL-A11**

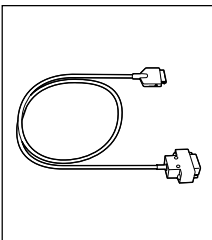

**Connecting cable T-A11 (for communication to a computer)**  
**Printer cable T-A12**

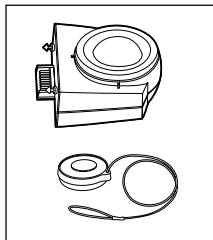

**Receptor Head**  
● Includes cap

# System Configuration Diagram

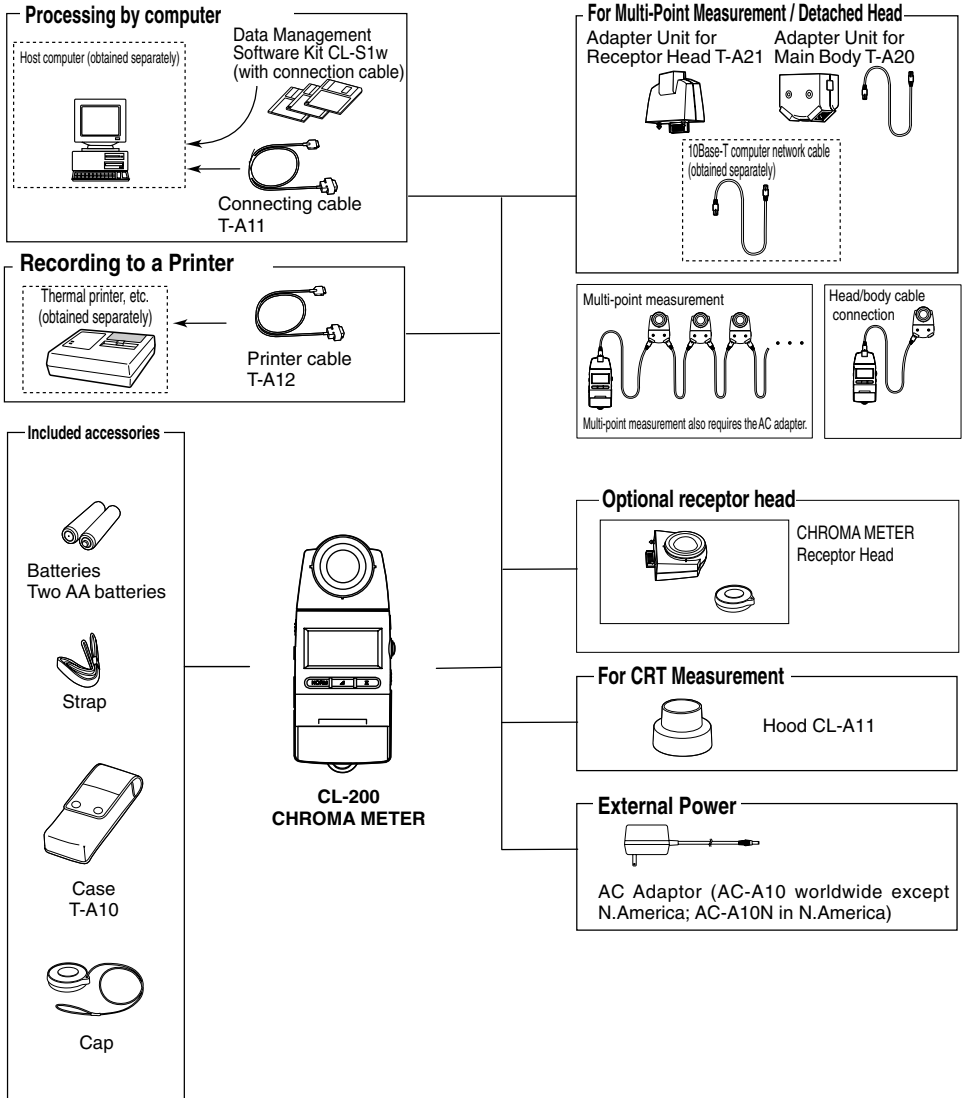

# ***Error Messages and Product Specifications***

---

## Error Messages

In the event of a problem, the CHROMA METER may display an error message. The following table shows the messages that may appear, their causes, and what you should do in response.

Message	What It Means	What To Do
ErrU	Unit error. Displayed at time of power-on if the body and head are not properly connected.	Set the power switch to OFF and then back to ON. If the message reappears, contact the nearest Minolta-authorized service facility.
ErrE Err	EEPROM error. Error in the data stored in the head's EEPROM.	Set the power switch to OFF and then back to ON. If the message reappears, contact the nearest Minolta-authorized service facility.
ErrA	Setting error. Attempted to set a value that was out of range.	Check the valid range, and make settings accordingly.
ErrC	Communication error. Error in communication between body and head.	Check for incorrect connection. If connections appear to be correct, contact the nearest Minolta-authorized service facility.



# Dimension Diagram / Illuminance Reference Plane

(Unit: mm)

The summit of the receptor window serves as the reference plane, as illustrated below.

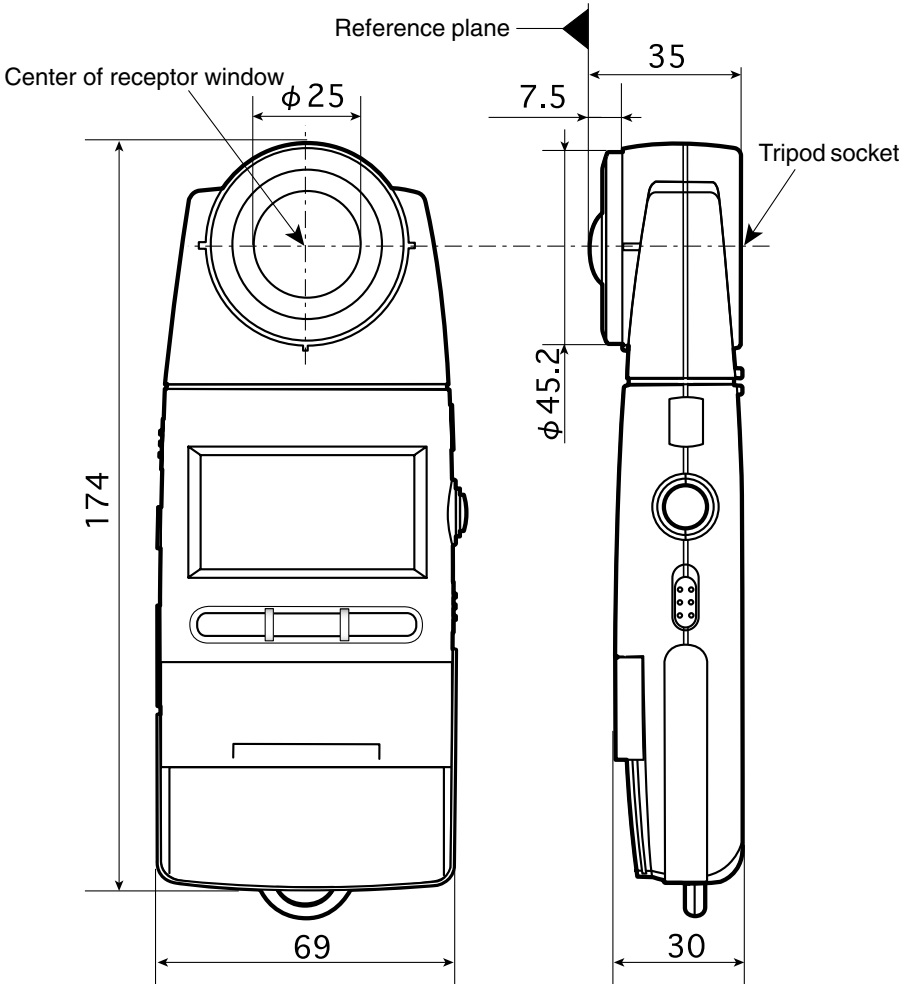

# Illuminance Measurement Capabilities

## Relative Spectral Response

The spectral response of an ideal illuminance meter would match  $V(\lambda)$ , the spectral luminance efficiency function for photopic vision. JIS (Japan Industrial Standards) has established a rating system that classifies illuminance meters according to how closely they match this function. The CL-200 CHROMA METER conforms to the “general class AA” classification.

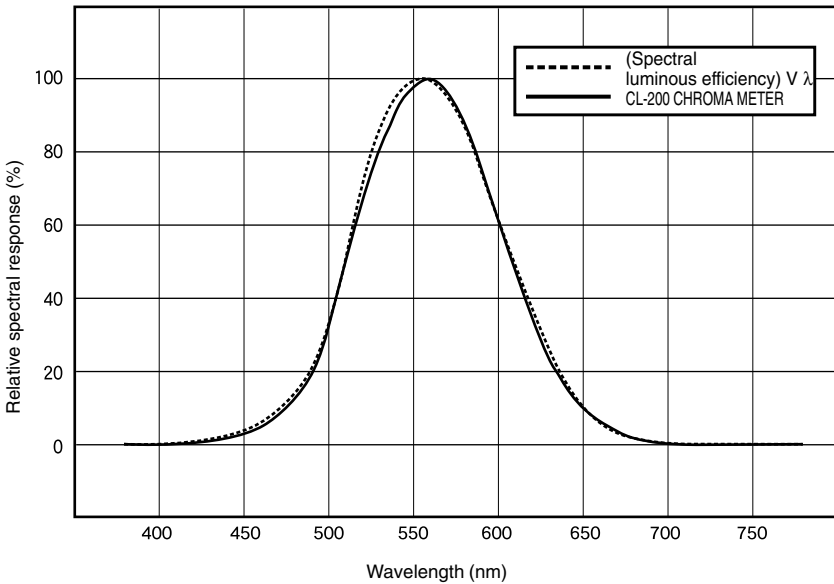

# Cosine Correction Characteristics

Because the brightness at the measurement plane is proportional to the cosine of the angle of incidence, the response of the receptor must also be proportional to this cosine. The graph below shows the cosine correction characteristics of the CL-200 CHROMA METER.

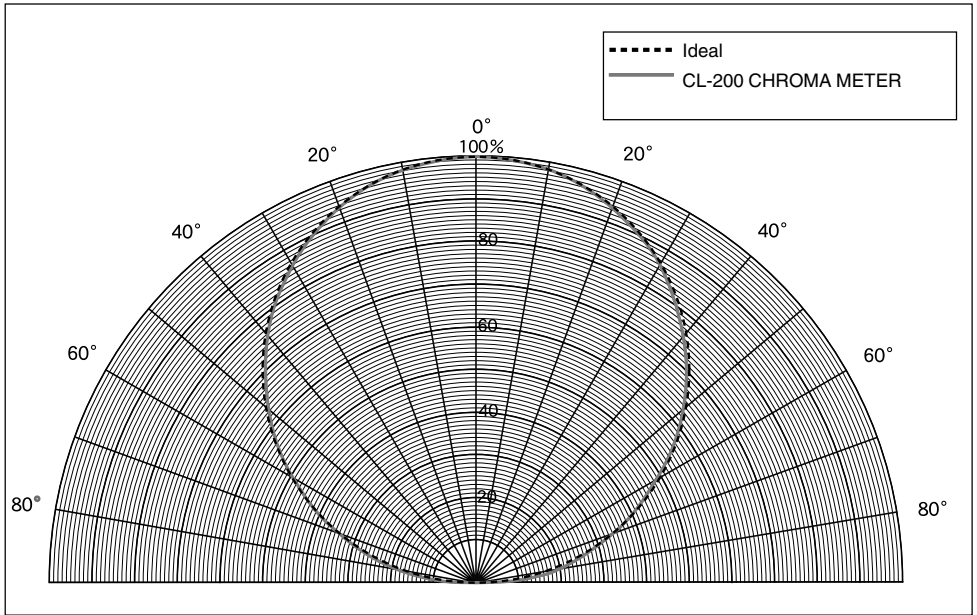

# Specifications

Model	CL-200 CHROMA METER
Relative Spectral Response	Closely matches CIE Standard Observer curves $\bar{x}(\lambda)$ , $\bar{y}(\lambda)$ , and $\bar{z}(\lambda)$ Within 8% (f1') of the CIE spectral luminous efficiency $V(\lambda)$
Receptor Element	SPC
Measurement Functions	Tristimulus values: X Y Z Color space: Ev x y, Ev u' v' Correlated color temperature: Ev, Tcp, Δuv Color difference display: Δ (X Y Z); Δ (Ev x y); Δ (Ev u' v'); ΔEv Δu'v' (One target color)
Other Functions	Calibration Modes (Normal, Multi) Correction (1 user-set channel for each calibration mode) Data hold; multi-point measurement (up to 30 connected heads)
Measuring Range	0.1 ~ 99,990 lx, 0.01 ~ 9,999 fcd (Chromaticity : 5 lx, 0.5 fcd or above) in four automatically selected ranges (lx or fcd is switchable)
Accuracy	Ev: ±2% ±1 digit of value displayed xy: ±0.002 (800 lx, standard illuminant A measured)
Repeatability	Ev: 0.5% + 1 digit (2σ) x, y: ±0.0005 (Standard illuminant A measured)
Temperature Drift	Ev: ±3% ±1 digit of value displayed, xy: ±0.003
Humidity Drift	Ev: ±3% ±1 digit of value displayed, xy: ±0.003
Measurement Frequency	2 times/sec (continuous)
Digital Output	RS-232C compliant
Display	4-column LCD, with automatic backlight
Operating Environment	Temp/Humidity: -10 to 40°C; not above 85% RH (at 35°C); no condensation Max. altitude: 2000m Product category: II Pollution degree: 2
Storage Environment	Temp/Humidity: -20 to 50°C; relative humidity 85% or less (at 35°C); no condensation
Power	Two AA batteries or dedicated AC adapter (optional)
Battery Life	60 hours or longer (when alkaline batteries are used for continuous measurement)
Consumed Current	Batteries: 3V $\text{---}$ , 50mA (when using 1 head) AC adapter: 9V $\text{---}$ , 300mA (when using 30 heads)
Dimensions; Weight	69 (W) × 174 (H) × 35 (D) [mm]; 215g (without batteries)
Included Accessories	case, cap, strap, batteries
Optional Accessories	Adapter Unit for Main Body T-A20, Adapter Unit for Receptor Head T-A21, AC adapter AC-A10 (AC-A10N in North America), Data Management Software Kit CL-S1w, Hard Case CL-A10, Hood CL-A11, Connecting Cable T-A11 (for PC), Printer Cable T-A12

- Specifications and appearance are subject to change without notice.







